

# "TAVOLA"

TABLE BASSE

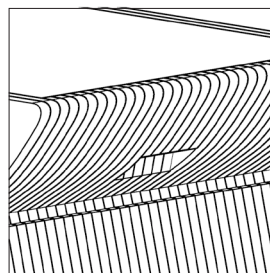
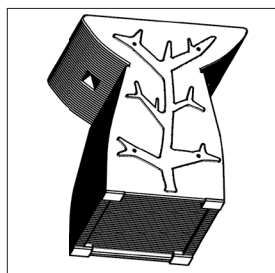
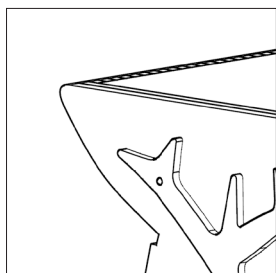
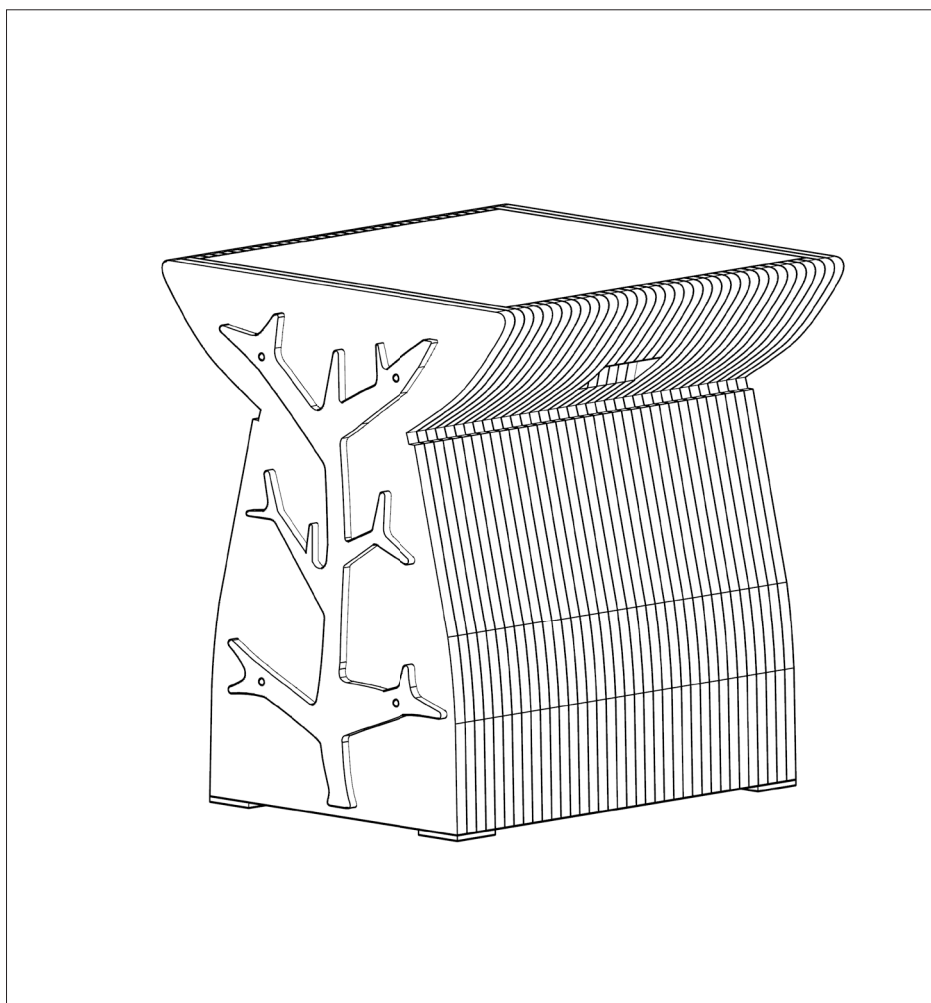

# "TAVOLA"

TABLE BASSE

architectonic

dessus 1:5

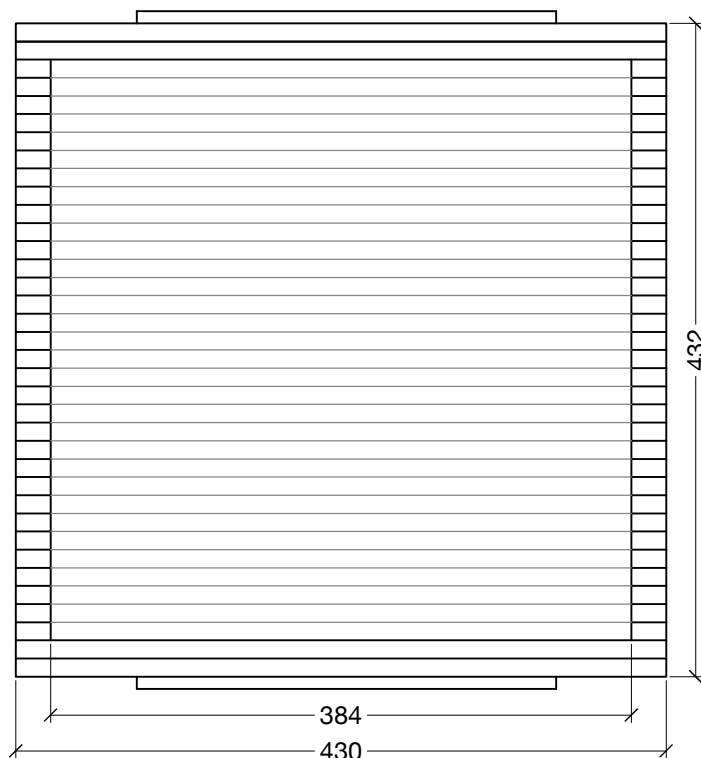

dessous 1:5

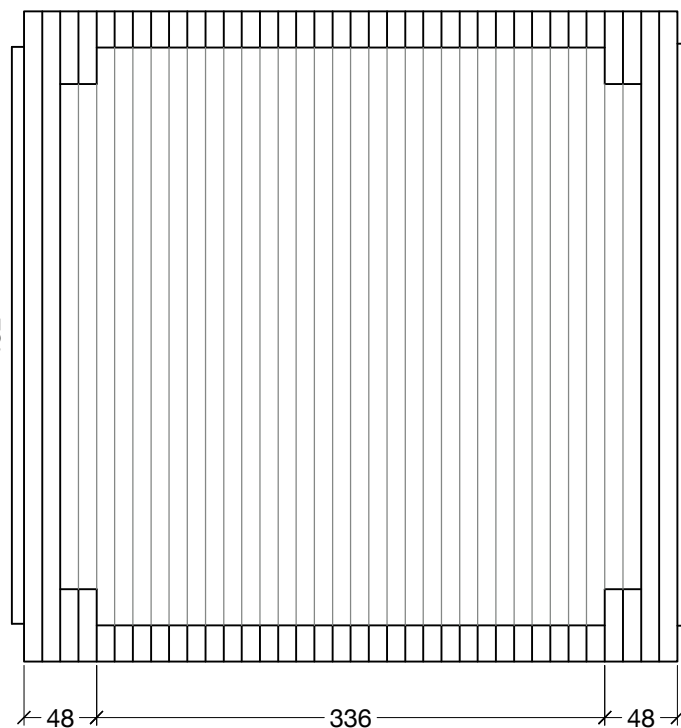

face 1:5

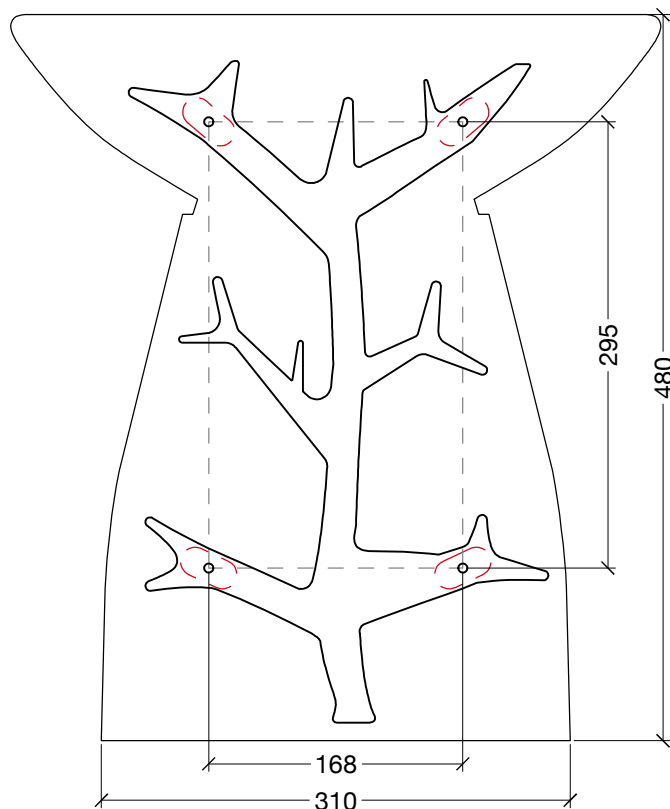

profil 1:5

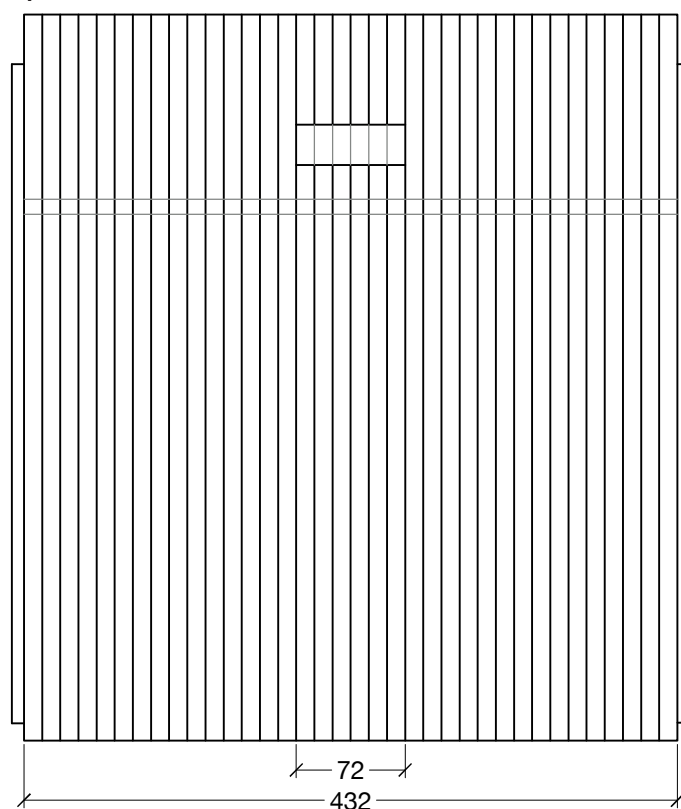

# "TAVOLA"

TABLE BASSE

## assemblage

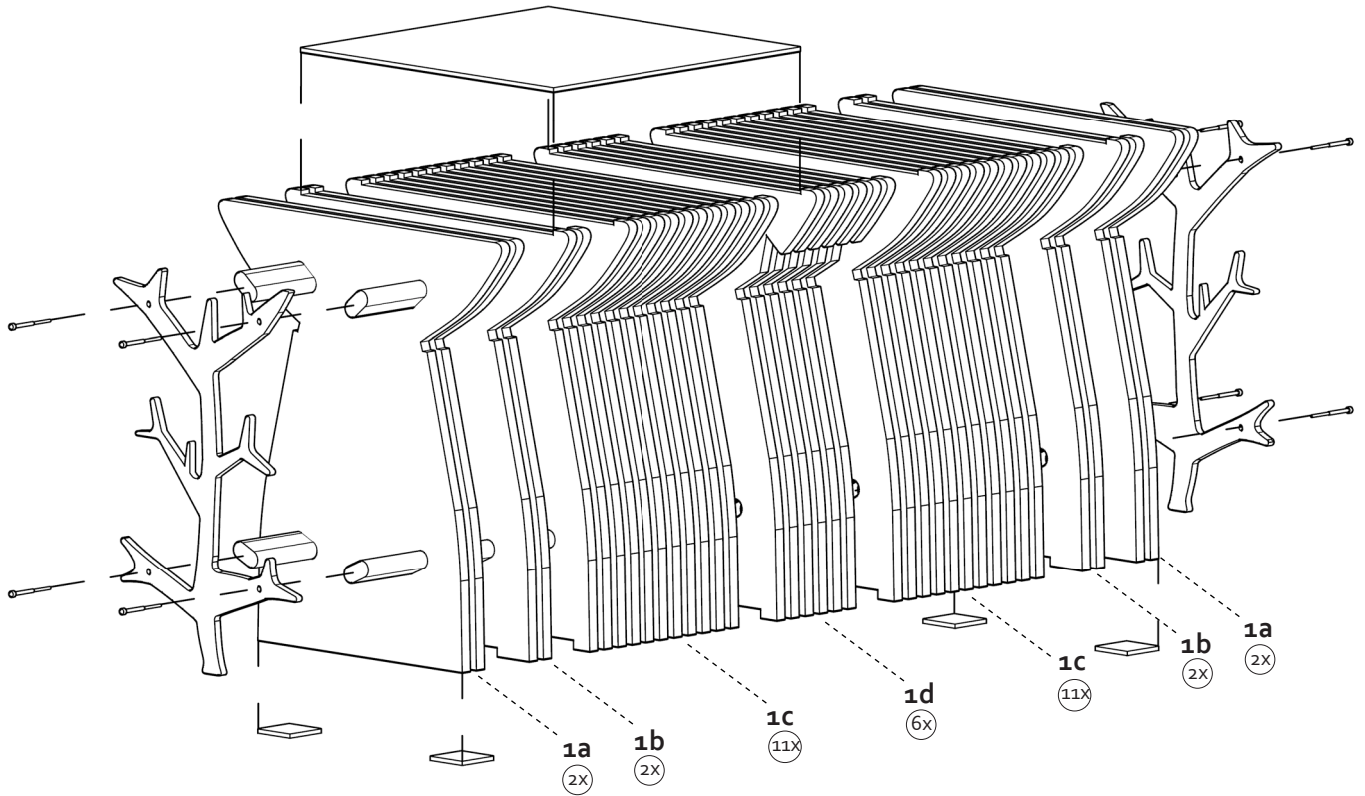

carton ondulé

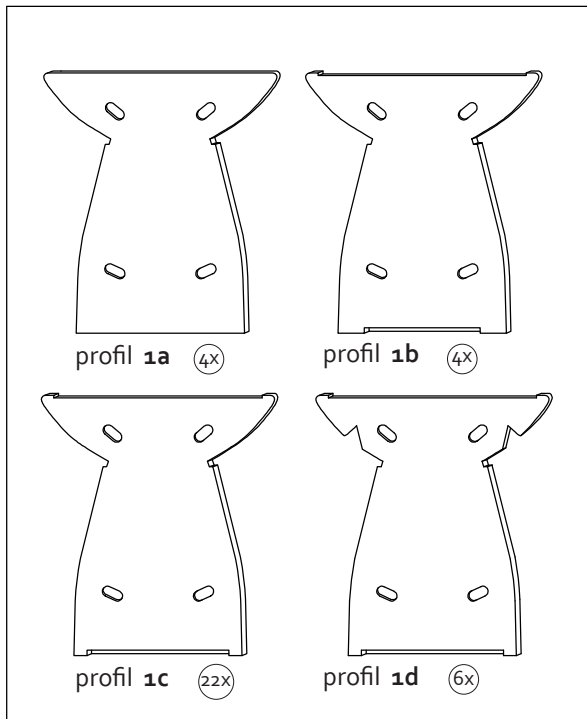

aluminium

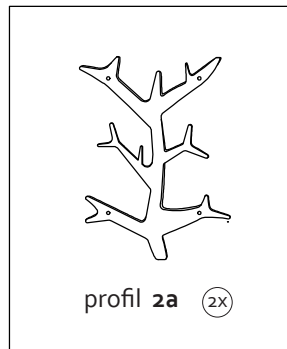

bois

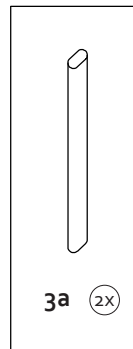

feutre

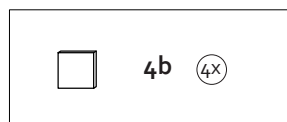

vis

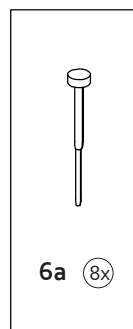

plaque photo

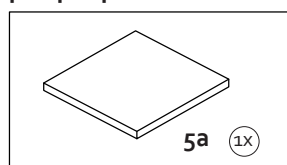

# "TAVOLA"

TABLE BASSE

## plan de découpe / carton ondulé

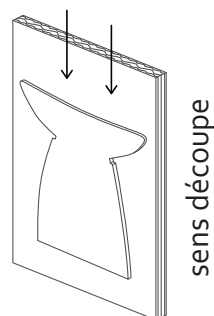

### 1. carton ondulé

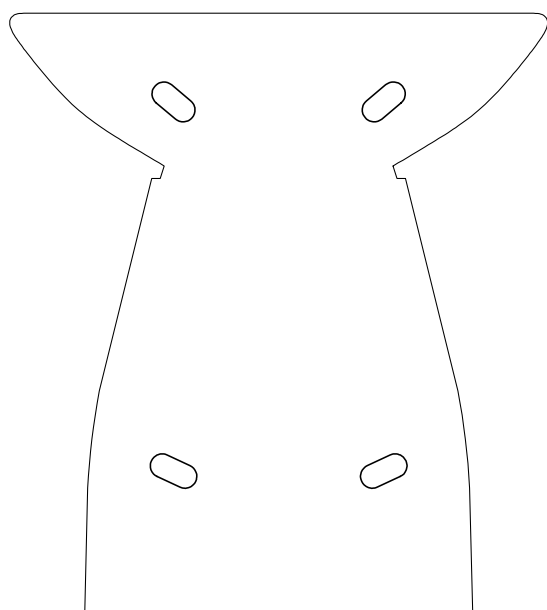

profil 1a

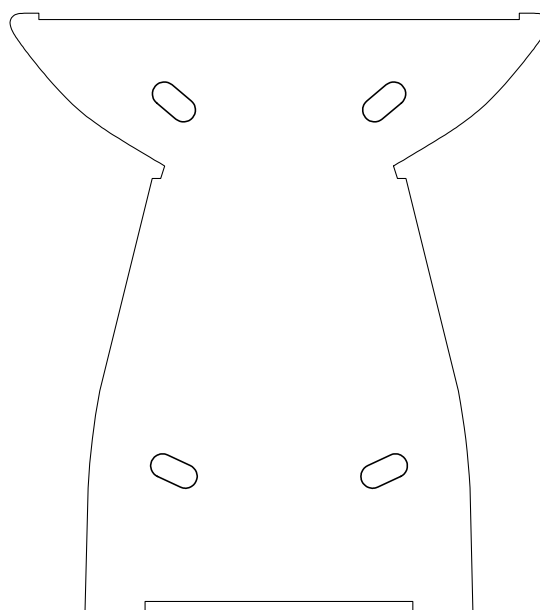

profil 1b

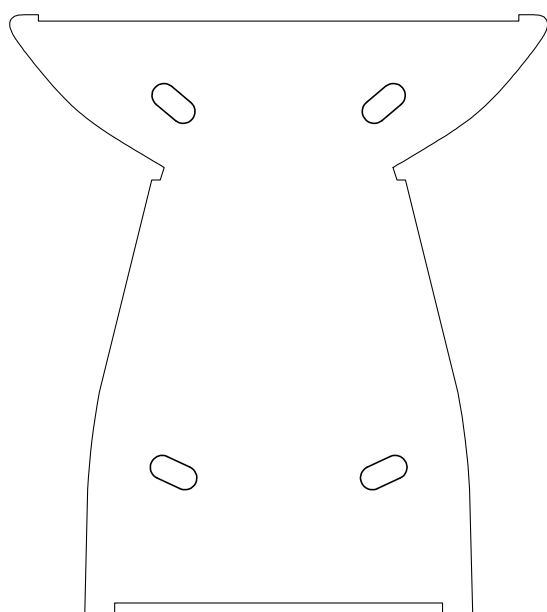

profil 1c

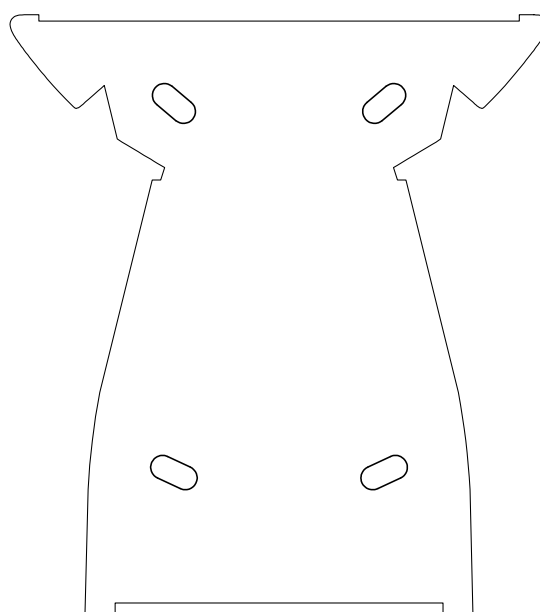

profil 1d

# "TAVOLA"

TABLE BASSE

plan de découpe / aluminium - bois - feutre

## 2. aluminium

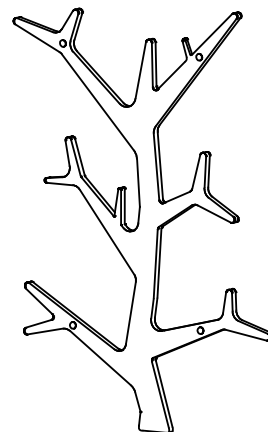
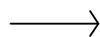
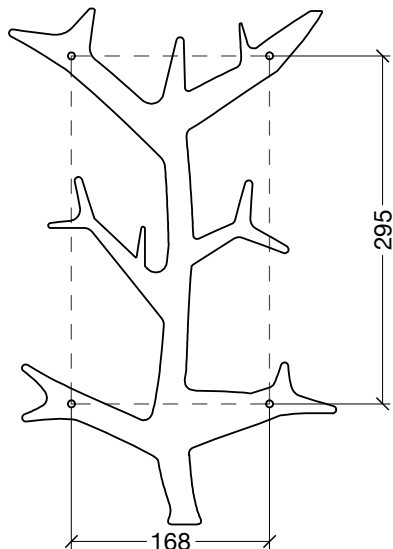

## 3. bois

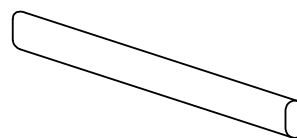
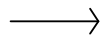
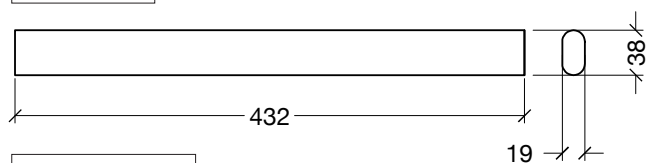

## 4. feutre

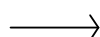
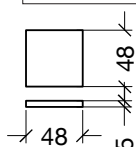

## 5. plaque photo

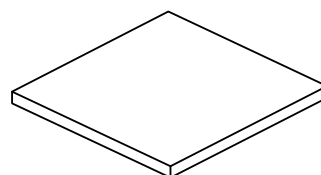
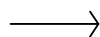
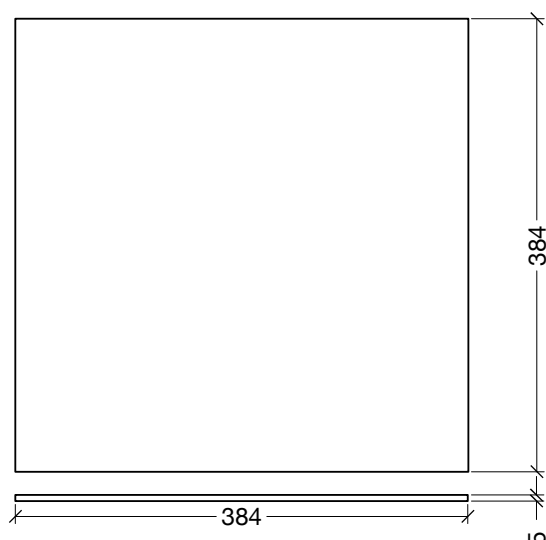

# "TAVOLA"

TABLE BASSE

## tableau récapitulatif

Éléments	unités	prix HT	prix TTC
<b>1a</b> Profil carton ondulé triple canelure - 12mm	X 4		
<b>1b</b> Profil carton ondulé triple canelure - 12mm	X 4		
<b>1c</b> Profil carton ondulé triple canelure - 12mm	X 22		
<b>1d</b> Profil carton ondulé triple canelure - 12mm	X 6		
<b>2a</b> Profil aluminium ref ..... - 8mm	X 2		
<b>3a</b> Bois Frêne	X 2		
<b>4a</b> Feutre ép 5mm - densité... - avec adhésif	X4		
<b>5a</b> Plateau avec photo type .....	X 1		
<b>6a</b> Vis type .....	X 8		